

M 4x20

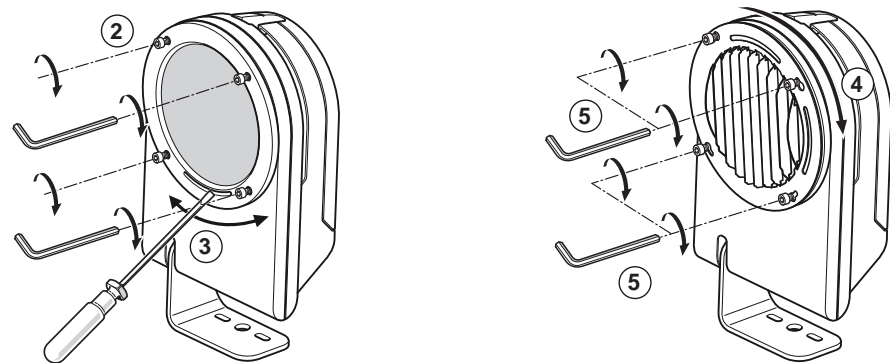

M 4x20

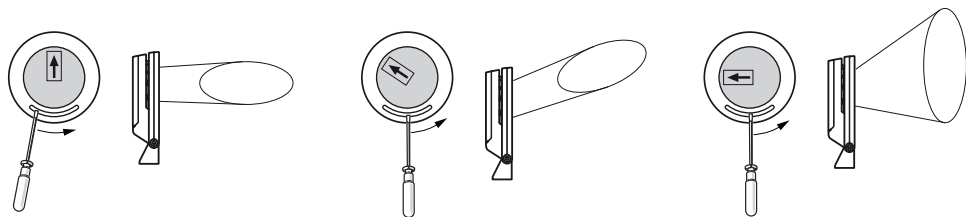
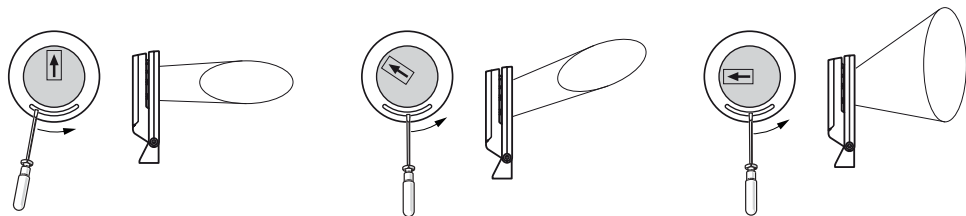

CONTRAST 2 LED

THORN

UK Installation instructions

FI Asennusohje

LV Instalācijas instrukcija

DE Montageanleitung

FR Notice de montage

NO Monteringsanvisning

CZ Montážní návod

HU Szerelési útmutató

PL Instrukcja montażu

DK Monteringsvejledning

IT Istruzioni di montaggio

SE Installationsanvisning

EE Paigaldusjuhend

LT Montavimo Instrukcijos

RU ИНСТРУКЦИЯ ПО МОНТАЖУ

TYPE : ACCESSORY

SMALL

MEDIUM

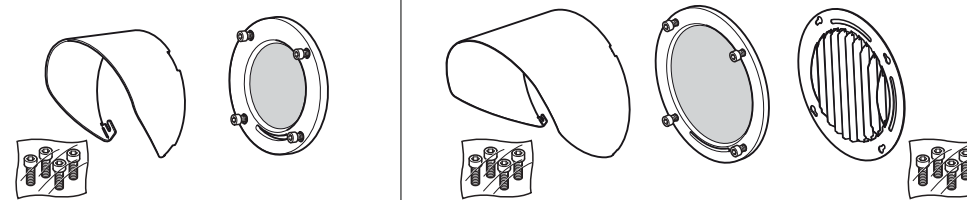

LARGE

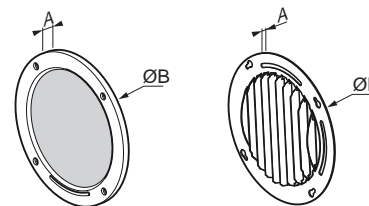
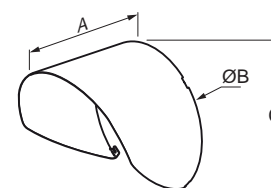
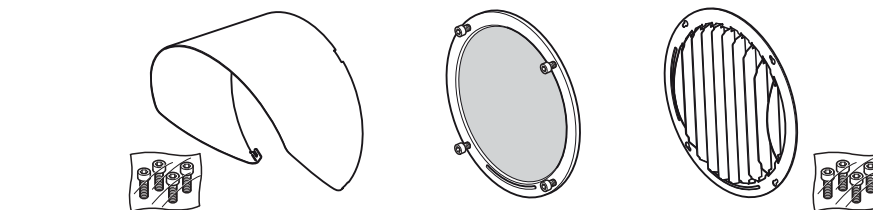

	SMALL		MEDIUM			LARGE	
(mm)							
A	75	11	146	11	17	200	11
ØB	114	117	192	195	193	292	295
C	103		170			254	
(kg)	0.064	0.117	0.212	0.260	0.078	0.433	0.490

